

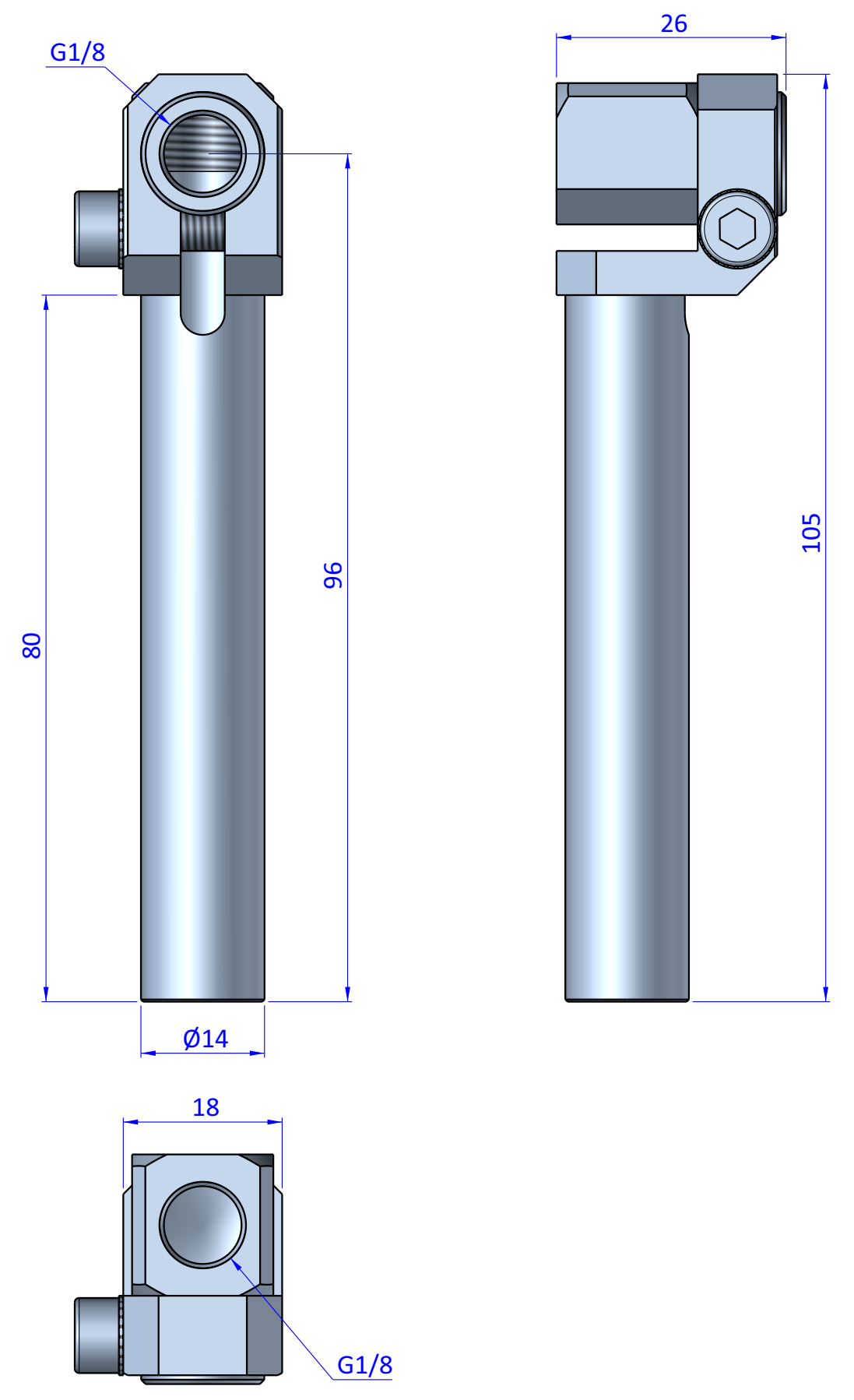

THE PROPERTY OF THE DRAWING IS ESTABLISHED BY LAW. IT IS FORBIDDEN TO PRODUCE OR SHOW IT TO THIRD PART. WITHOUT A WRITTEN AGREEMENT.

Item	Name	Q.ty
1	GGB.14.18.18	1
2	GGB.14.80	1
3	R.5.SCH	1
4	V.TCE5x18	1

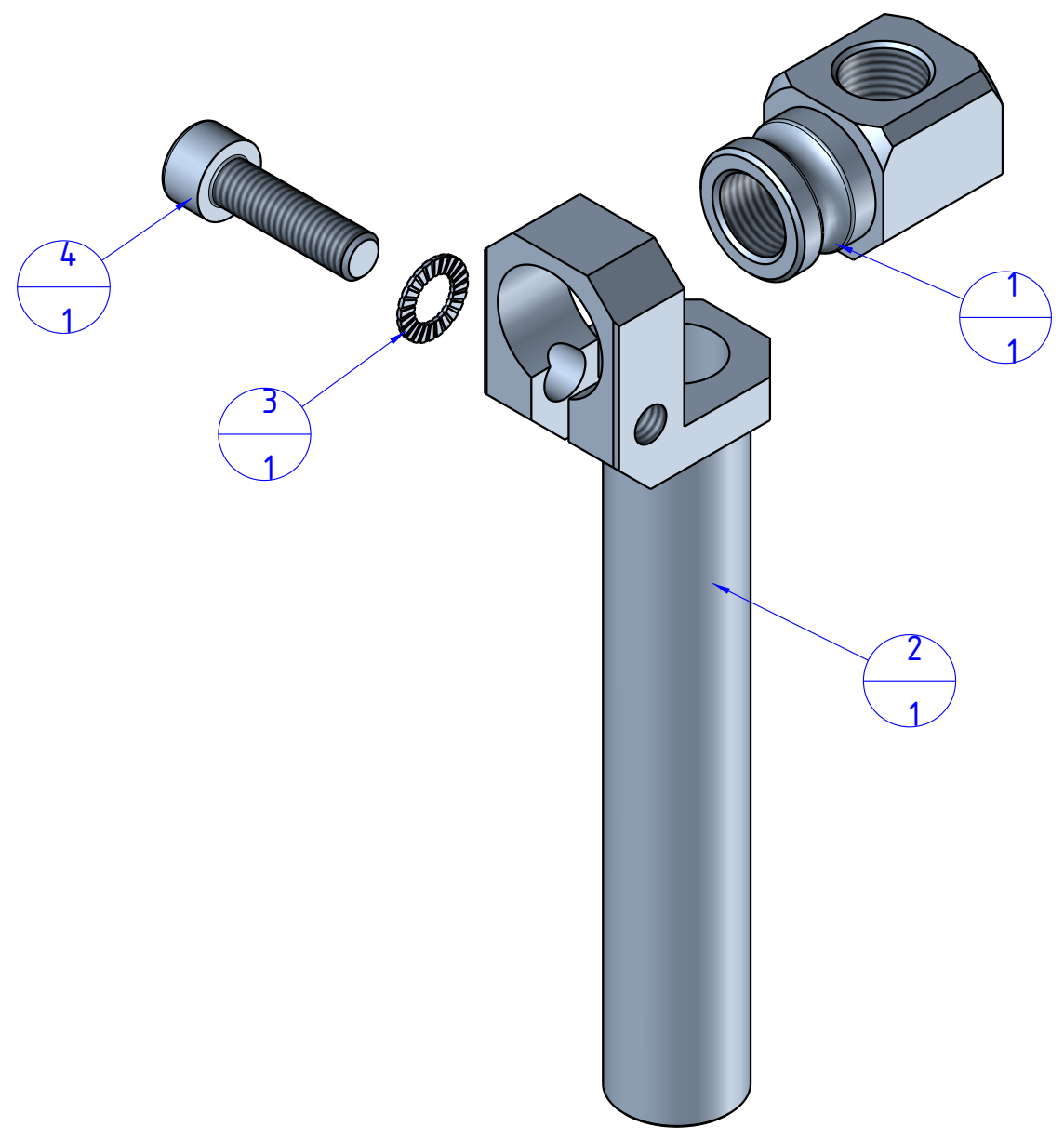

Format A3  
UNI 936-76

 <b>FPS</b> FPSERVICES AUTOMATION		DESIGNED FROM		REVIEW
		FPS Automation		A
GENERAL TOLERANCE		DATE		WEIGHT
UNI - ISO 2768		06/08/2020		0,038kg
CLASSE f		CODE		
		CA.GGB.14181880		CA.GGB.14181880